

SEND FORM

Gazelle Script Form

Tennis Sports Wheelchair

MELROSE PRODUCT CODE 00000

Melrose
KIWI CONCEPT CHAIRS USA

Date _____

Name _____

Address _____

Phone _____

Fax / Cell phone _____

Email _____

Delivery Details and nearest Airport _____

Required by _____

(Delivery is normally 4-6 weeks from order confirmation)

To Order
Fill in the frame dimensions and features required. For variations describe in detail on a separate page. If you have any further questions contact us at the address below.

Grading _____ Disability _____

Weight _____ Height _____ Shoe Size _____

MEASUREMENTS (Refer to diagram)

Materials Aluminium Titanium

Wheels 4 3

Width _____	D Seat to footplate _____	I Pivot centres _____
A Sling _____	E Wheel base _____	J Dist. between wheels _____
Sling taper _____	F Seat to floor - front (centre of camber bar to centre of castor pivot) _____	K Foot plate position _____
B Back height _____	G Seat to floor - Rear _____	L Anti tip position _____
C Back angle _____	H Balance point _____	M Camber _____

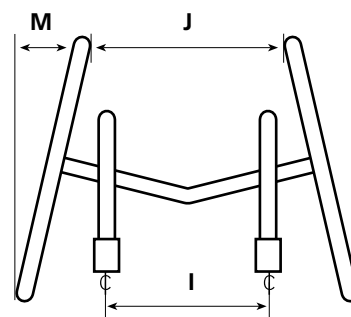
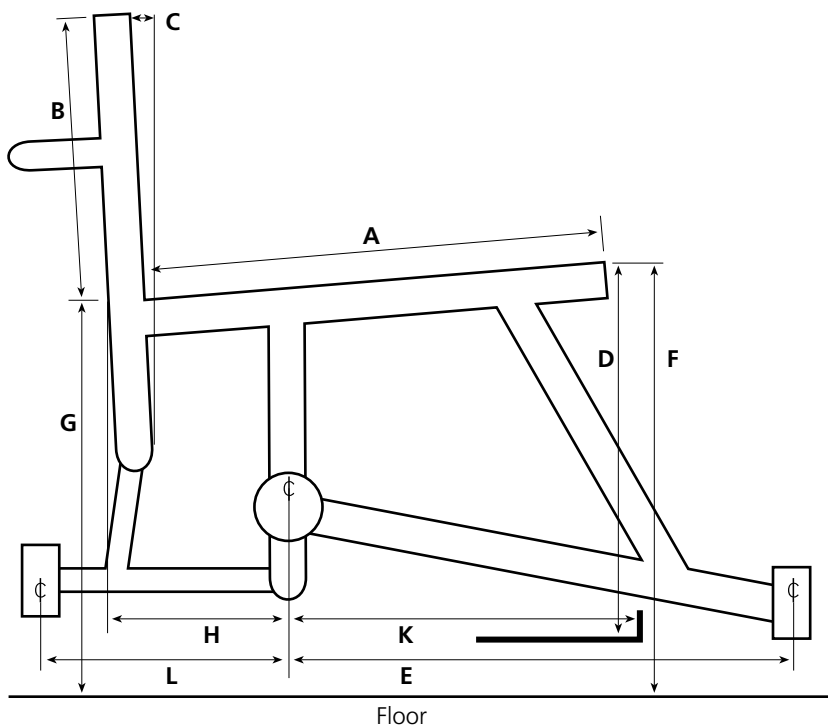

Gazelle Script Form

Tennis Sports Wheelchair

Name _____

FOOTPLATE

- No ABS on footplate ABS on footplate

ANTI-TIPS

- Twin swivel - welded Single swivel - welded

CASTORS

- 76 R/B Other

WHEELS

- Standard cross spoked
 Spinergy wheels
 24" 26" - 559 26" - 590
 No wheels - but set up for _____

TYRES

- High pressure IRC Tyres
 Continentals Kenda

PUSHRIMS

- Hard anodised Other

PUSHRIMS - POSITION

- Standard In close On to rim

UPHOLSTERY

- Adjustable back (Adj ht and adj width)
 Fixed back (Adj ht - non adj width) Width at _____
 Fabric skirt guards ABS skirt guards
 Alloy skirt guards - Height _____
 Hip strap Footstrap
 Cushion 2" Cushion 1"
 No cushion

SPARE WHEELS

- Spare wheel (one only)
 Set of wheels - spare

GRAB HANDLE

- Left Right Both

ACCESSORIES

- Wheel bag (Black with choice of trim colour)
 Red Blue Green
 Purple Yellow Black
 Pink
 Axles Quantity _____

NOTES

Gazelle Script Form

Tennis Sports Wheelchair







Name _____

Attention





This is a guide to colours only, how colours appear on your monitor or when printed out may vary. Contact us if you require assistance or a colour sample.

COLOURS





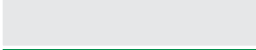

Blue / Purple

- 1 Royal Blue 
- 8 Coral Blue Sparkle 
- 19 Deep Purple 
- 26 Navy Blue 
- 51 Sky Blue 
- 53 Pommel Blue 
- 60 Purple Pan 

Green

- 2 Hawthorn Green 
- 7 Sea Green Sparkle 
- 9 Deep Teal 
- 18 Clear 
- 54 Mistletoe 
- 58 Tyrol Green 

Red / Orange / Yellow

- 3 Lemon 
- 11 Flame 
- 44 Golden Yellow 
- 48 Burgundy 
- 56 Satin Gold 
- 57 Super Hot Chilli 
- 71 Pure Orange 

Silver

- 12 Silver Orbiter 
- 29 Metallic Grey 
- 41 Saxon Grey 
- 42 Metallic Viper 
- 49 Gloss White 
- 52 Anotec Silver Grey 
- 55 Silver Sparkle 

Black

- 30 Satin Black 
- 61 High Gloss Black 
- 62 Matt Black 
- 63 Texture Matt Black 

Candy Colours

- 15 Chrystal Amethyst 
- 17 Chrystal Sapphire 
- 27 Candy Blue 
- 28 Candy Red 
- 68 Chrystal Yellow 
- 70 Candy Emerald 
- 72 Glass Blue 
- 73 Chrystal Jade 
- 76 Chrystal Bronze 
- 77 Chrystal Copper 
- 78 Chrystal Rose 

Pearl (additional cost)

- 13 Fine Blue Pearl 
- 14 Fine Black Pearl 
- 45 Lilac Pearl 
- 67 Green Pearl 

Bead Blast

(titanium only)



Custom Colour (additional cost)

Description